

E.S.P.

Emergent Synthetic Processes

Introduction to a New Approach to Automation

Keith D Swenson

Fujitsu America

April 2019

The Process Model

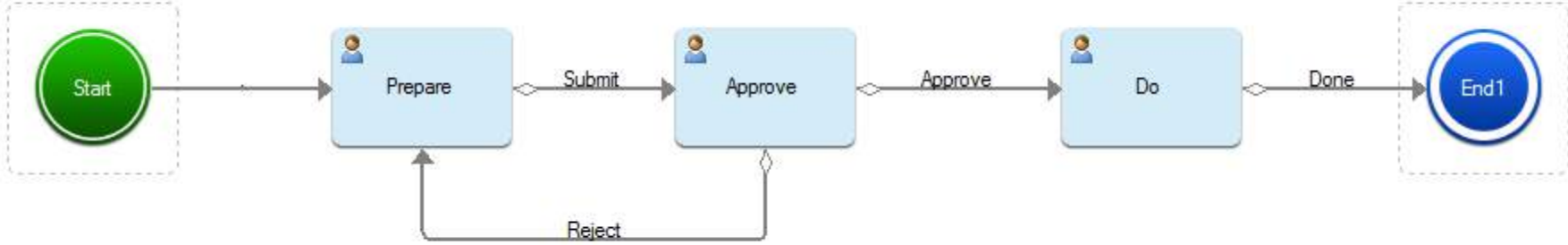

Coming to Agreement

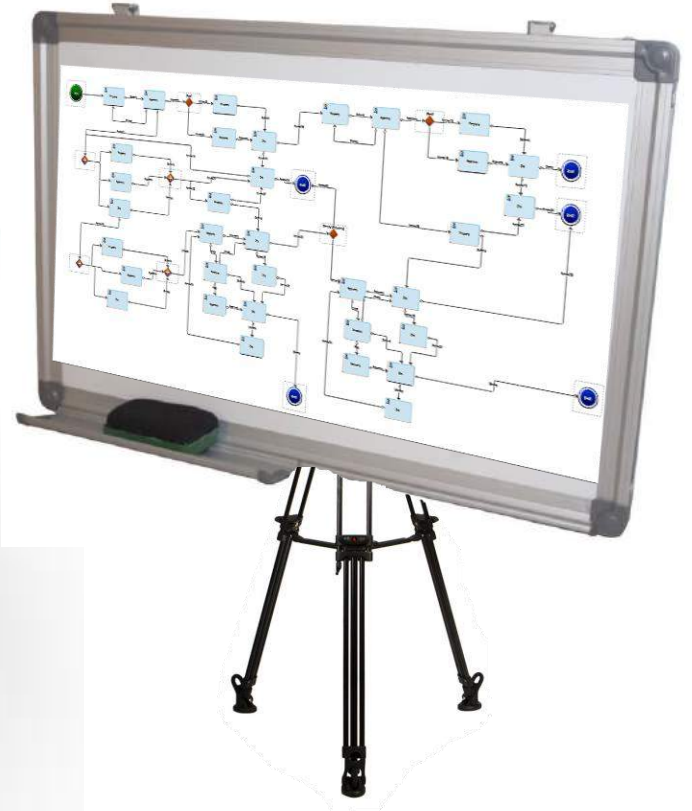

Time →

AGREEMENT!

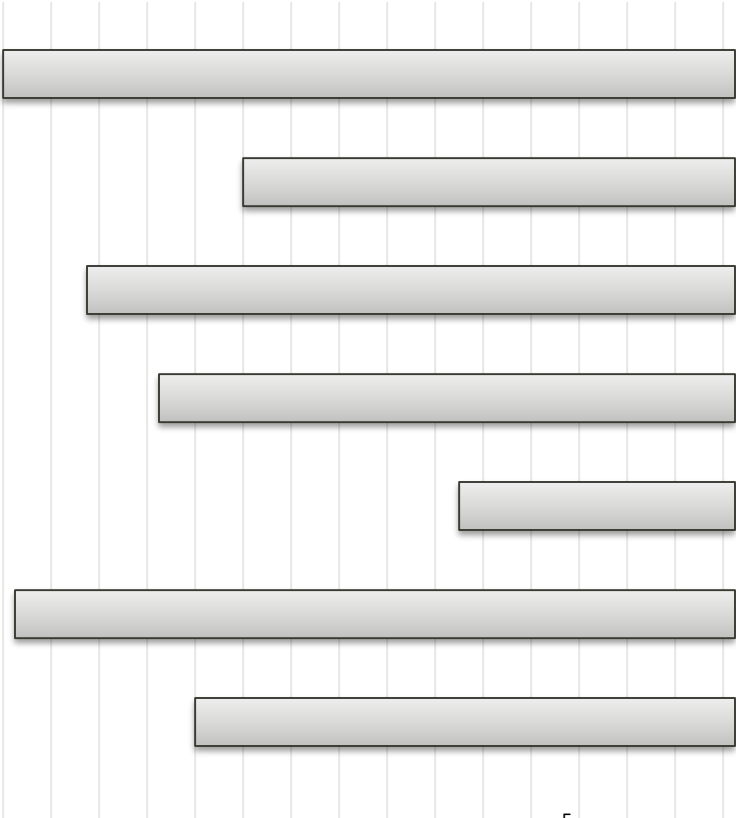

No
Change

Just Define “Service Descriptions”

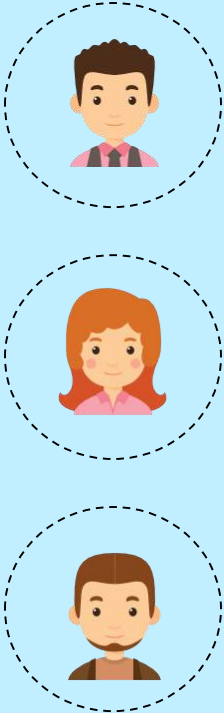

Job 1

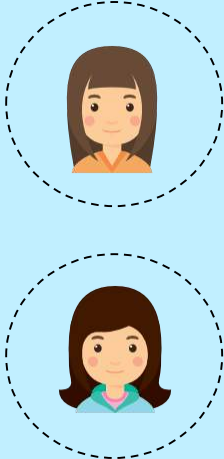

Job 2

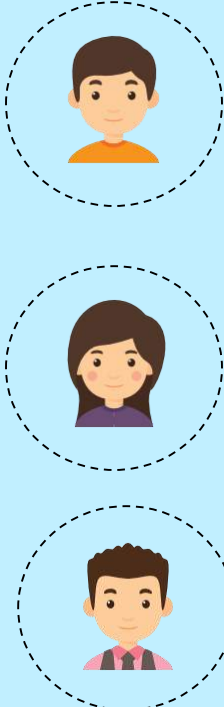

Job 3

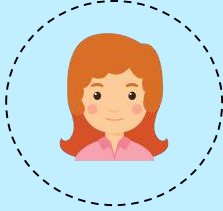

Job 4

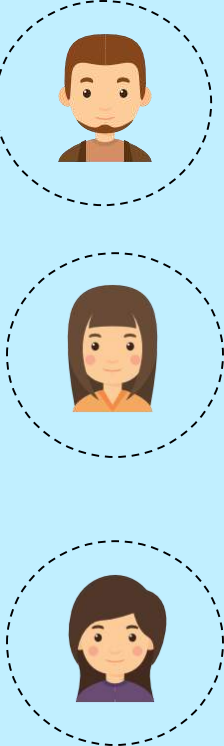

Job 5

Find Optimum Route through Organization

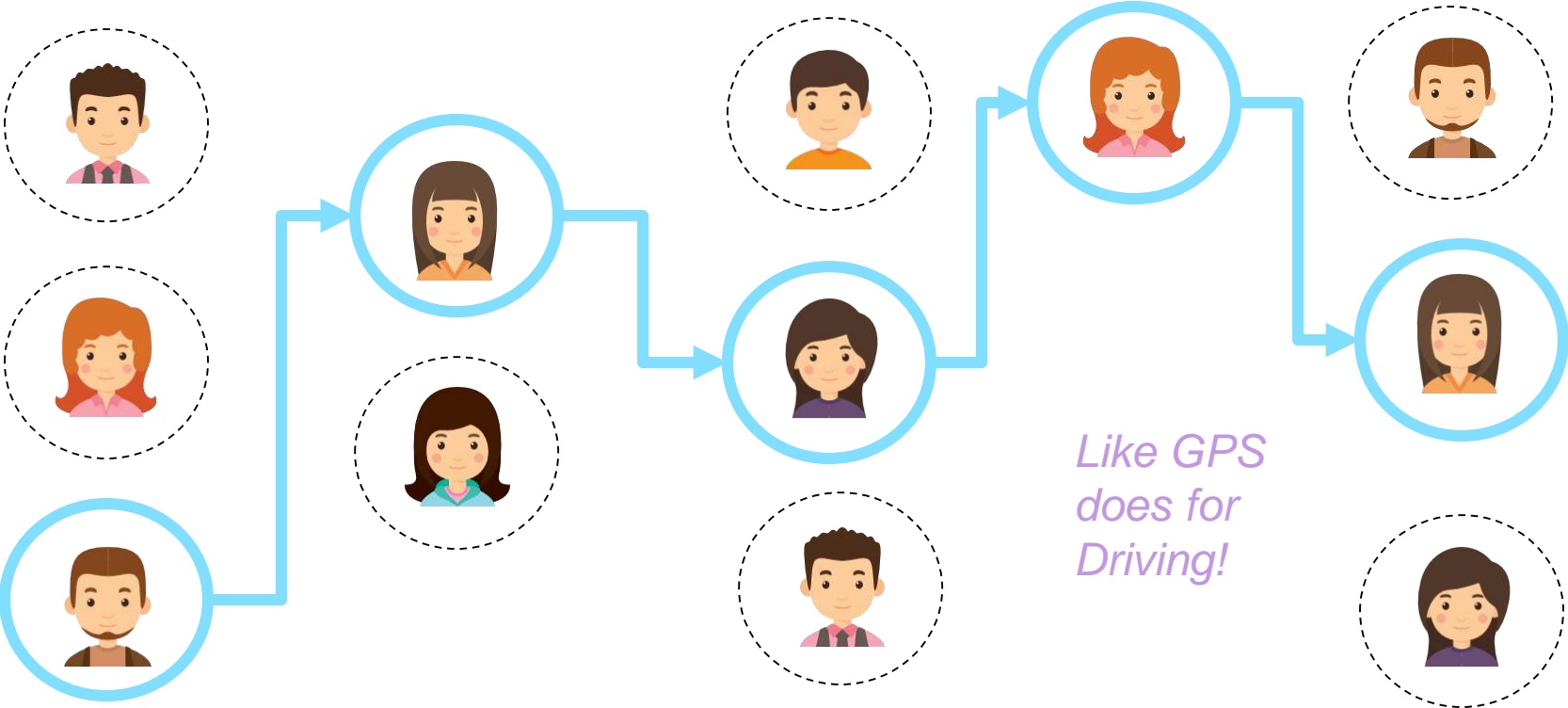

*Like GPS
does for
Driving!*

Job 1

Job 2

Job 3

Job 4

Job 5

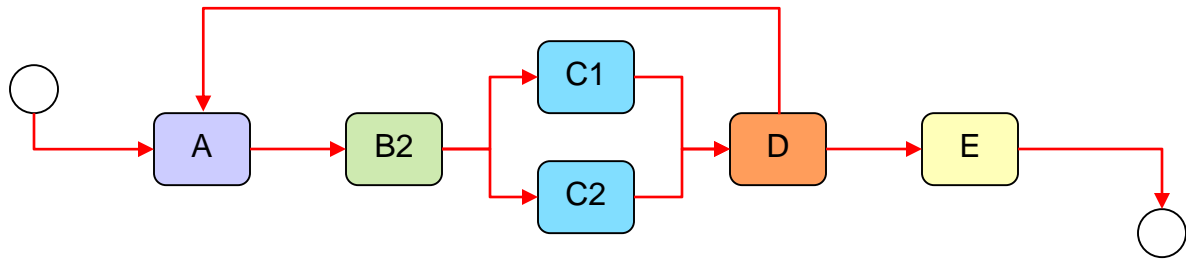
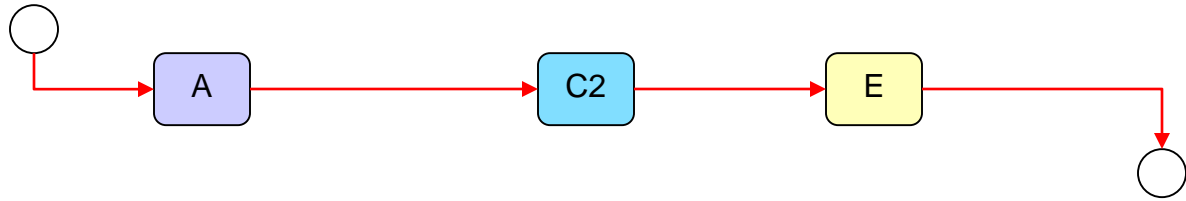
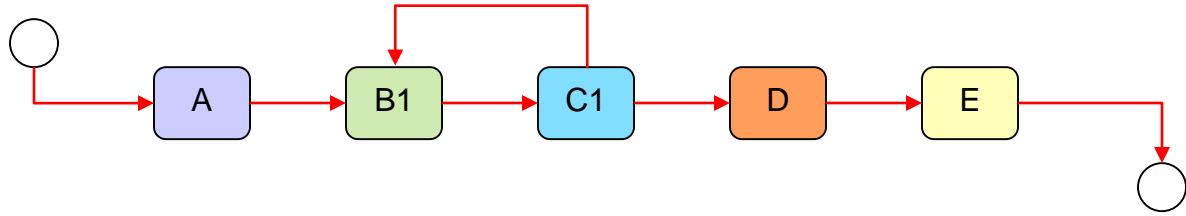

Decomposition – Service Description Extraction

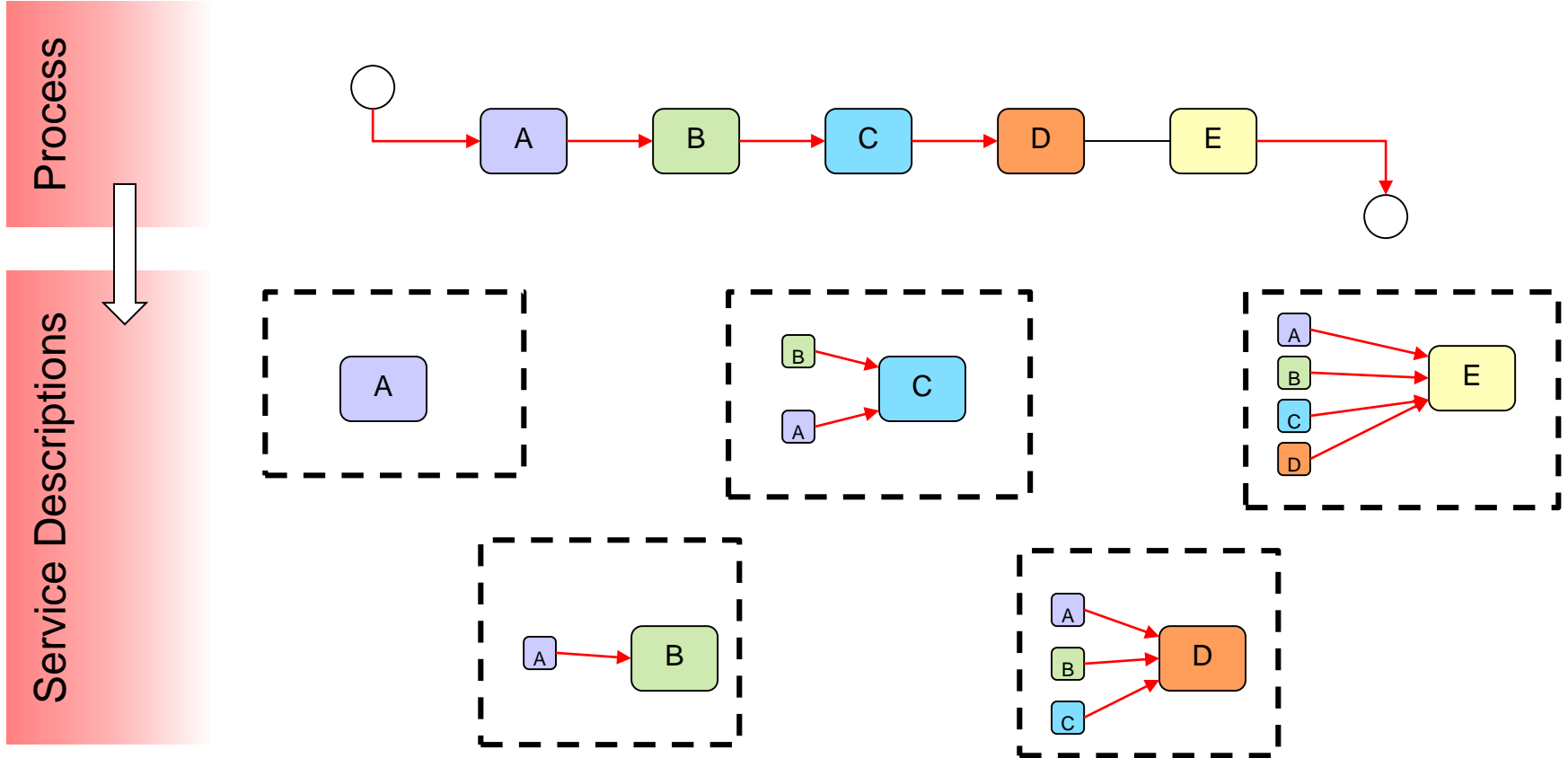

Service Description

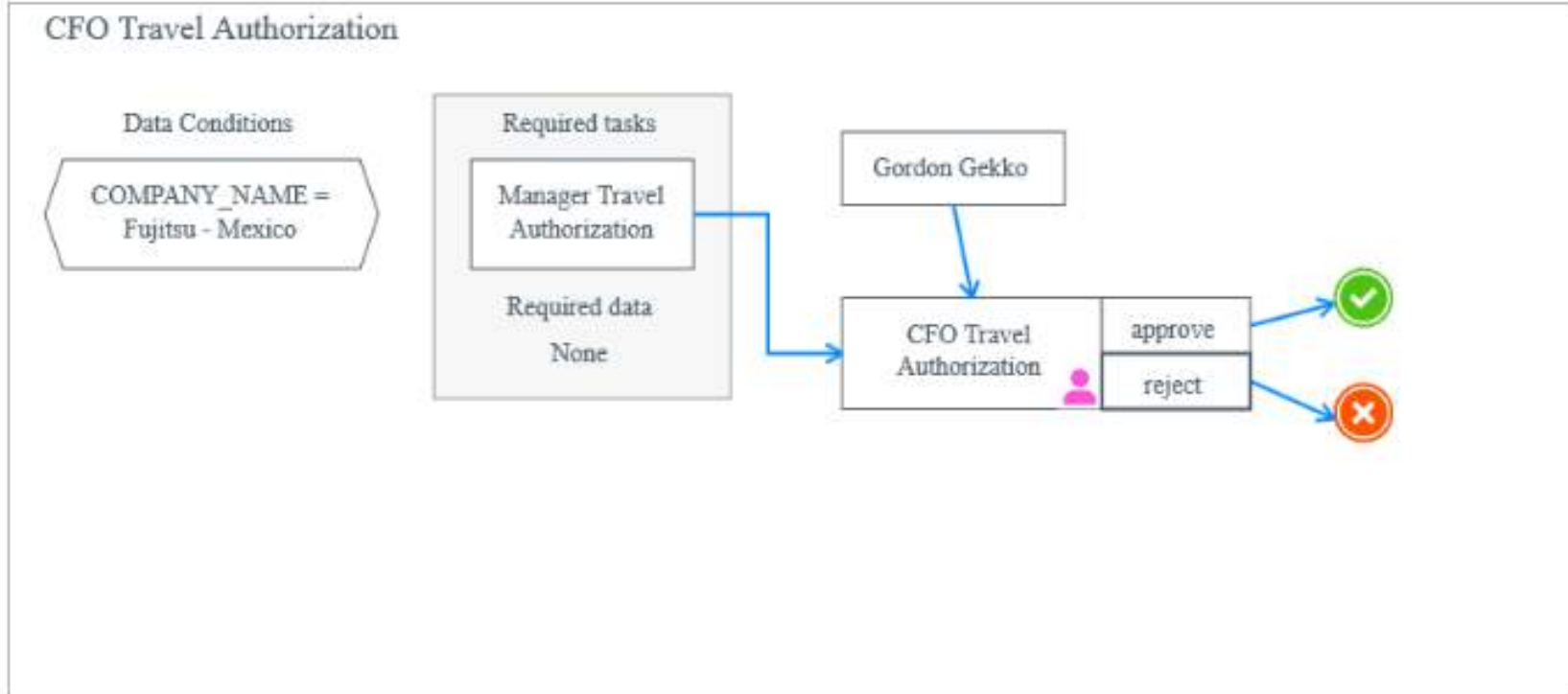

Process Synthesis

Service Descriptions

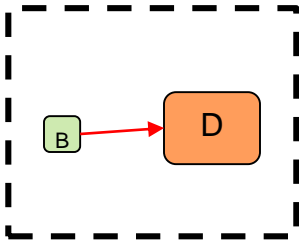
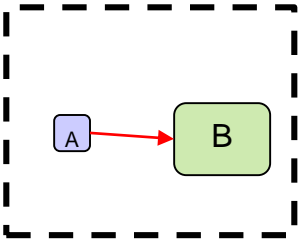
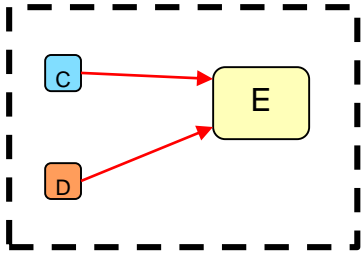
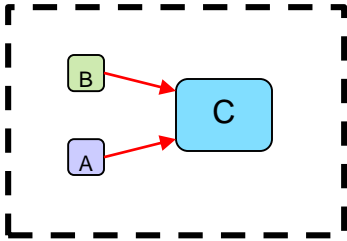
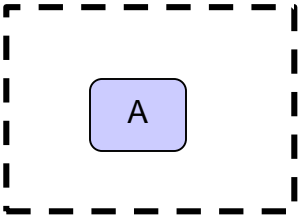

Process

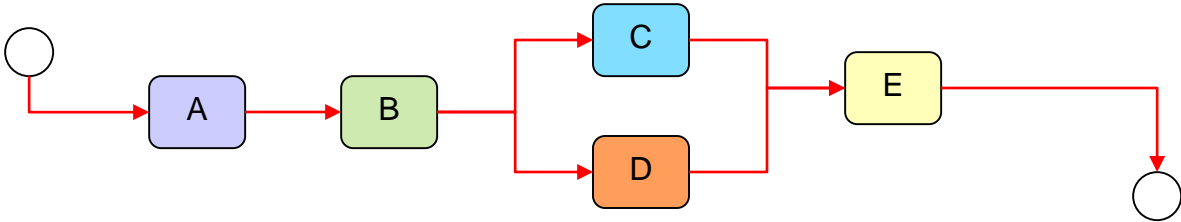

Synthesis – Adding a Task

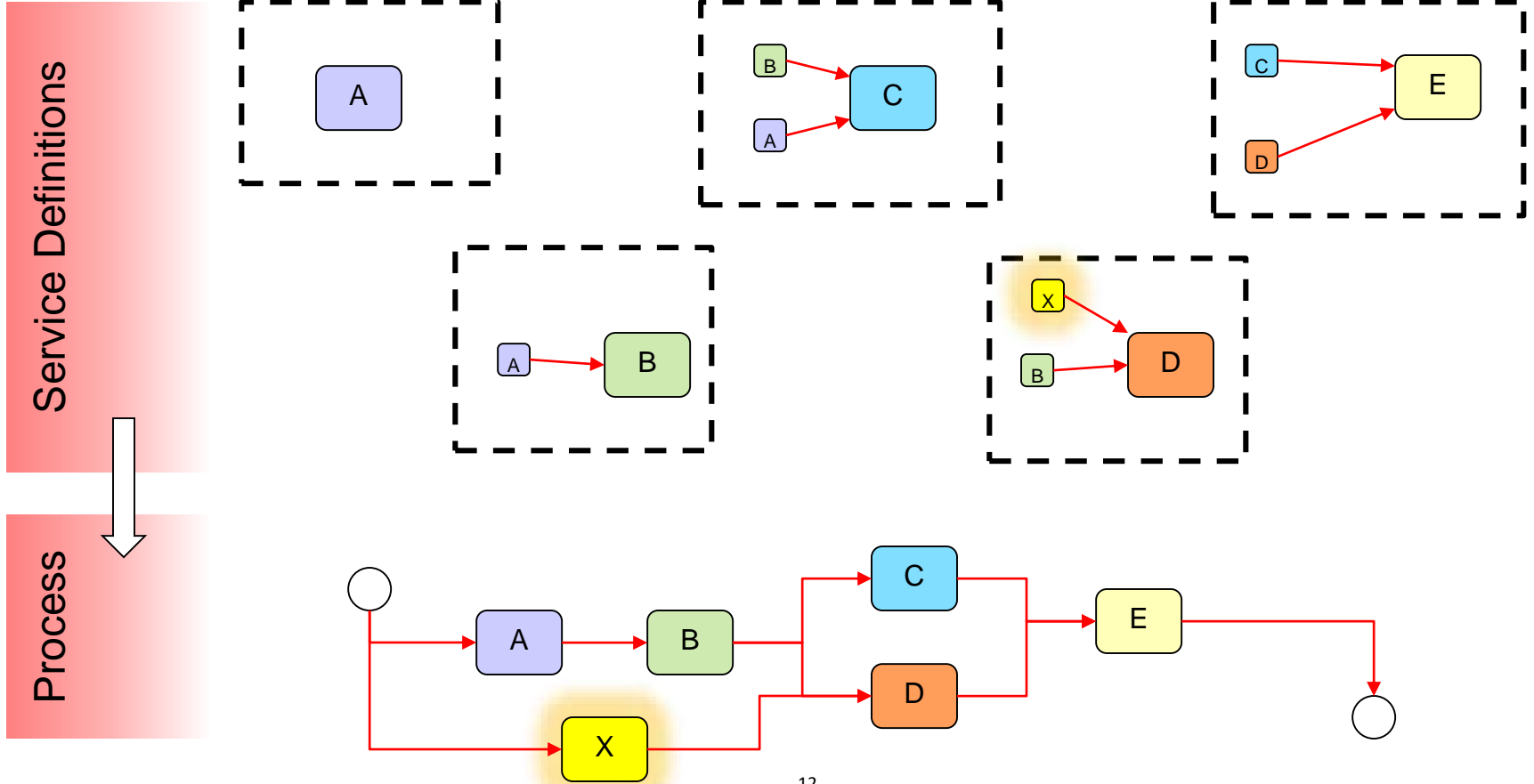

Synthesis – Removing Task

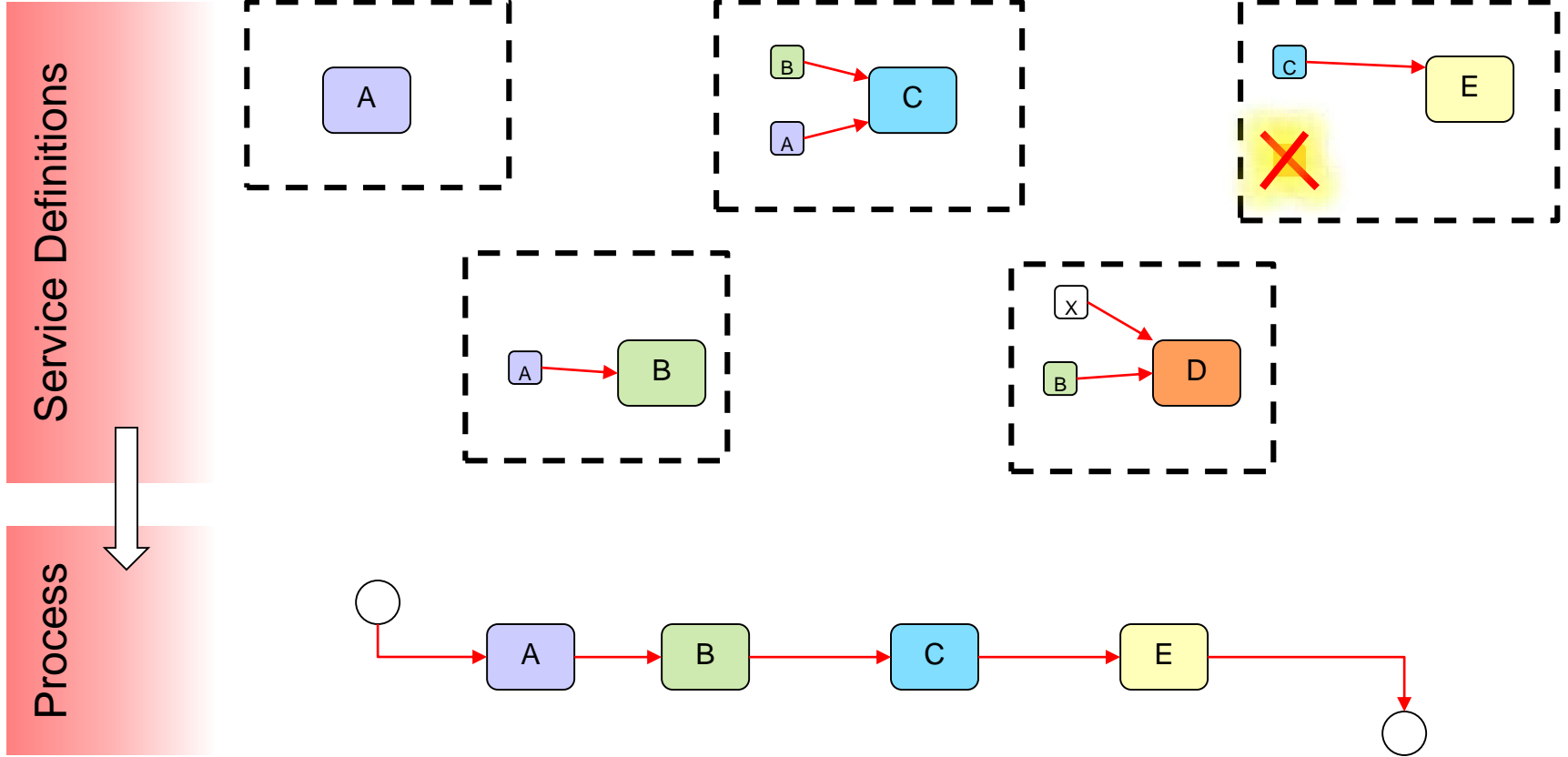

Fully Distributed – Deployed Into Agents

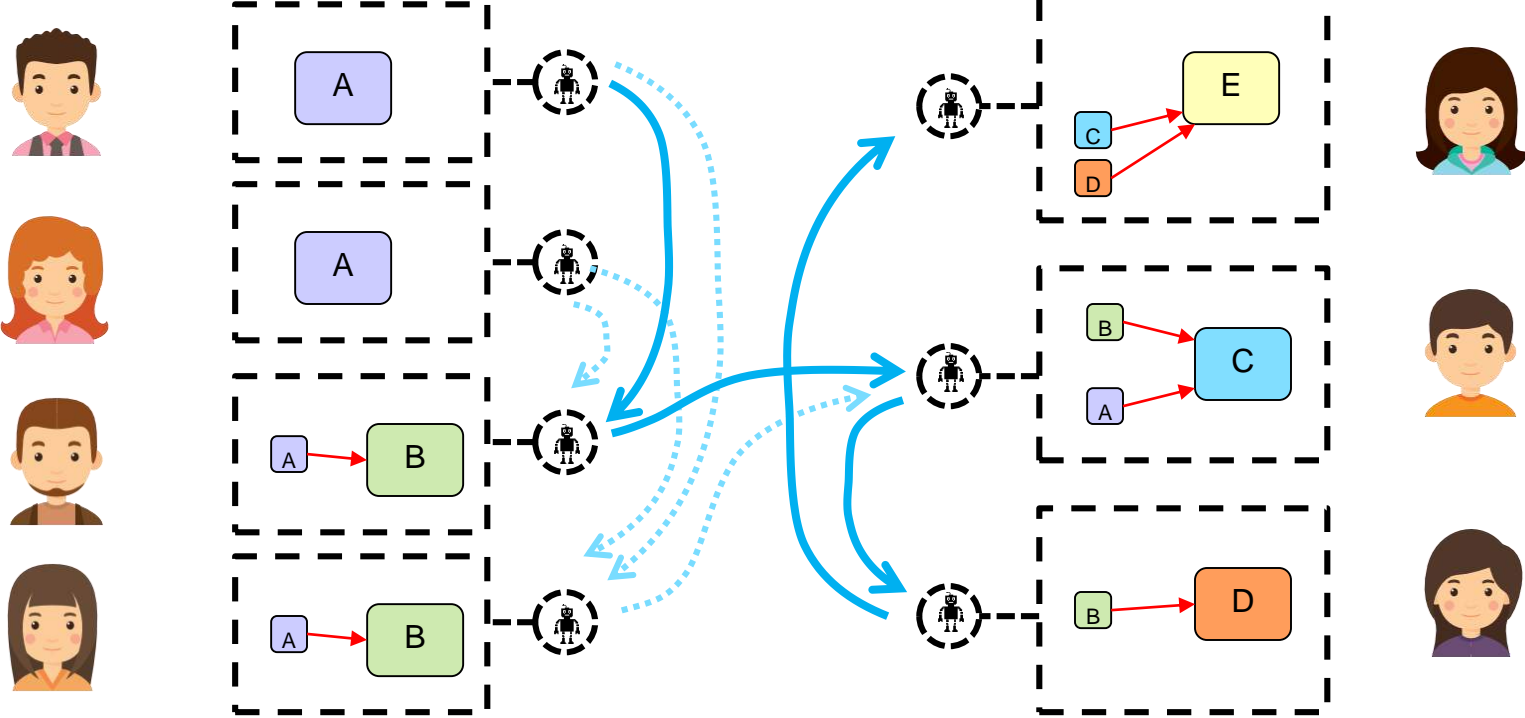

Protocol Steps

1. Are You Able to Perform the Job?
2. What do you Need to Perform the Job?
3. When can you perform the Job?
4. Formal Request to schedule Job.
5. Formal Confirmation of Acceptance of Conditions
6. Delivery of Prerequisites, Update Inputs
7. Update Status, Delivery of Results

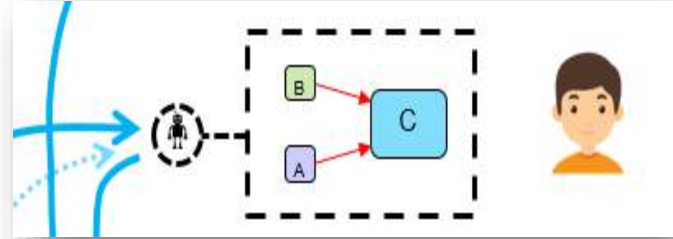

At any time: Monitor, Check Status, Cancel, Refresh Request

Benefits of this Approach

- Service Descriptions be changed at any time
 - Without needing agreement from others
 - Partially complete processes can be updated whenever SDs change
- Synthesized Processes always meet requirements of all users
 - Service Descriptions are an explicit description of their requirements
- Synthesized Processes are optimized for the individual case
 - Worker schedules or workloads can be used to find the best schedule
 - Cost factors can be used to balance between fast / slow options
- Cross-organization processes can synthesized equally well
- Enables a “Gig-Economy” either within or beyond an organization

upwork

Hire freelancers.
Make things happen.™

fiverr

Find The Perfect
Freelance Services For
Your Business

A Q U E N T

FUJITSU

WE ARE
**CHANGING
THE WAY THE
WORLD WORKS**

 **SimplyHired**

One Search,
Millions of Jobs

 **freelancer**

Hire expert freelancers
for any job, online

 **peopleperhour**

Live your work dream

 **toptal™**

Hire the Top 3%
of Freelance Talent™

crowded

We Automate Talent
Acquisition

 **flexjobs**

FIND A BETTER
WAY TO WORK

Example Use Case – Travel Authorization

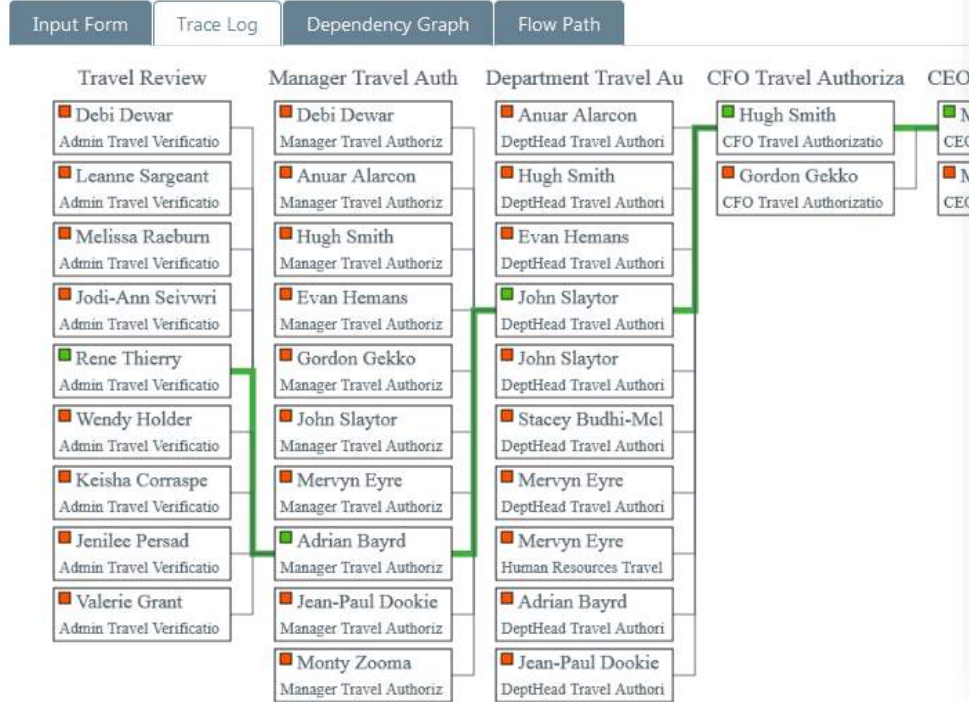

Travel-App admin logout

[New Request](#) [Request List](#) [Services](#) [Inbox](#) [Settings](#)

Status of Request

Request Date: Request State:

Approver Name	Status	Date	Task	Comments

Travel Summary

Traveler Name: Traveler Email:

Approval Manager: Manager Email:

Travel Dates: Destination:

Travel Details

Company Handling the request:

Employee Business Unit/Department:

Purpose:

Reasons:

Over 1st 2000

Any Other Company Members making same trip? If yes Identify:

Yes

No

Expenditure covered by? If client please specify YO No:

Fujitsu

Client

Mobile Receiving Required: Voice Data

Anticipated Number of Days Away:

Impact of Not making the trip:

Over 1st 2000

Expected Cost of Travel

Select an admin to verify/Enter the cost:

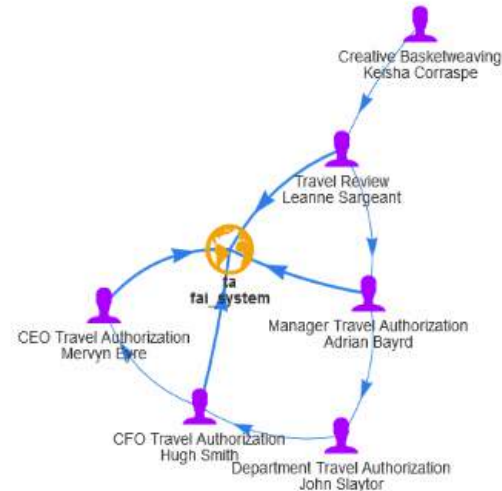
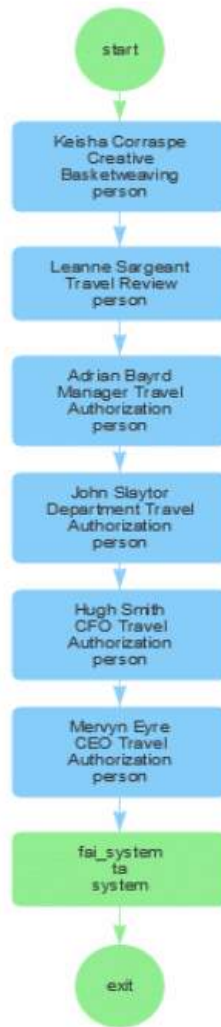

E.S.P.

Emergent
Synthetic
Processes

